

# Always there to help you

Register your product and get support at  
[www.philips.com/welcome](http://www.philips.com/welcome)

SHB8000



## User manual

# PHILIPS



# Contents

---

<b>1</b>	<b>Important safety instructions</b>	<b>2</b>
	Hearing Safety	2
	General information	2

---

<b>2</b>	<b>Your wireless on-ear headset</b>	<b>3</b>
	What's in the box	3
	Other devices	3
	Overview of your wireless on-ear headset	3

---

<b>3</b>	<b>Get started</b>	<b>4</b>
	Charge your headset	4
	Pair the headset with your mobile phone	4

---

<b>4</b>	<b>Use your headset</b>	<b>5</b>
	Connect the headset to a Bluetooth device	5
	Manage your calls and music	5
	Wear your headset	6
	Use with the audio cable	6

---

<b>5</b>	<b>Technical data</b>	<b>7</b>
----------	-----------------------	----------

---

<b>6</b>	<b>Notice</b>	<b>8</b>
	Declaration of conformity	8
	Disposal of your old product and batteries	8
	Notice for the European Union	9
	Trademarks	9

---

<b>7</b>	<b>Frequently asked questions</b>	<b>10</b>
----------	-----------------------------------	-----------

# 1 Important safety instructions

## Hearing Safety



### Danger

- To avoid hearing damage, limit the time you use the headset at high volume and set the volume to a safe level. The louder the volume, the shorter the safe listening time is.

### Be sure to observe the following guidelines when using your headset.

- Listen at reasonable volumes for reasonable periods of time.
- Be careful not to adjust the volume continuously upwards as your hearing adapts.
- Do not turn up the volume so high that you can't hear what's around you.
- You should use caution or temporarily discontinue use in potentially hazardous situations.
- Excessive sound pressure from earphones and headset can cause hearing loss.
- Using the headset with both ears covered while driving is not recommended and may be illegal in some areas while driving.
- For your safety, avoid distractions from music or phone calls while in traffic or other potentially dangerous environments.

## General information

To avoid damage or malfunction:



### Caution

- Do not expose the headset to excessive heat.
- Do not drop your headset.
- Headset shall not be exposed to dripping or splashing.
- Do not allow your headset to be submerged in water.
- Do not use any cleaning agents containing alcohol, ammonia, benzene, or abrasives.
- If cleaning is required use a soft cloth, if necessary dampened with a minimum amount of water or diluted mild soap, to clean the product.
- The integrated battery shall not be exposed to excessive heat such as sunshine, fire or the like.

### About operating and storage temperatures and humidity

- Operate or store in a place where temperature is between -15°C (5°F) and 55°C (131°F) (up to 90% relative humidity).
- Battery life may be shorter in high or low temperature conditions.

This Philips appliance complies with all applicable standards and regulations regarding exposure to electromagnetic fields.

## 2 Your wireless on-ear headset

Congratulations on your purchase, and welcome to Philips! To fully benefit from the support that Philips offers, register your product at [www.philips.com/welcome](http://www.philips.com/welcome).

With this Philips wireless on-ear headset, you can:

- enjoy convenient wireless handsfree calls;
- enjoy and control wireless music;
- switch between calls and music;
- enjoy music on non-Bluetooth devices with an audio cable.

### What's in the box



Philips Bluetooth wireless on-ear headset  
SHB8000

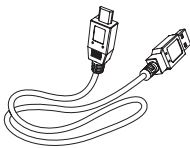

USB charging cable (for charging only)



Audio cable





Quick start guide

### Other devices

A mobile phone or device (e.g. notebook, PDA, Bluetooth adapters, MP3 players etc) which supports Bluetooth and is compatible to the headset.

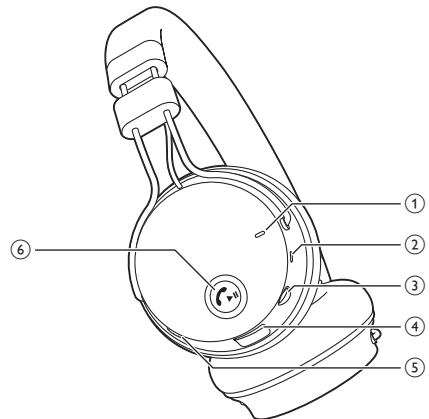
### Overview of your wireless on-ear headset



- ① LED lights
- ② Microphone
- ③ Audio cable jack
- ④ Charging slot
- ⑤ Volume/Track control button
- ⑥  Call/Music button

# 3 Get started

## Charge your headset

### Note

- Before you use your headset for the first time, charge the battery for 5 hours for optimum battery capacity and lifetime.
- Use only the original USB charging cable to avoid any damage.
- Finish your call before charging the headset, as connecting the headset for charging will power the headset off.

Connect the supplied USB charging cable to:

- the USB connector of the headset and;
- USB power source.

↳ LED turns white during charging and turns off when the headset is fully charged.

### Tip

- Normally, a full charge takes 3 hours.
- When your battery is empty, you can carry on listening music with an audio cable. Make sure the headset is off (and not in idle mode) before using this audio cable.

## Pair the headset with your mobile phone

Before you use the headset with your mobile phone for the first time, pair it with a mobile phone. A successful pairing establishes a unique encrypted link between the headset and mobile phone. The headset stores the last 8 devices in the memory. If you try to pair more than 8 devices, the earliest paired device is replaced by the new one.

- 1 Make sure that the mobile phone is turned on and its Bluetooth feature is activated.

- 2 Make sure that the headset is fully charged and turned off.
- 3 Press and hold  until the blue and white LED flashes alternately.
  - ↳ The headset remains in pairing mode for 5 minutes.
- 4 Pair the headset with the mobile phone. For detailed information, refer to the user manual of your mobile phone.

The following example shows you how to pair the headset with your mobile phone.

- 1 Activate the Bluetooth feature of your mobile phone, select Philips SHB8000.
- 2 Enter the headset password "0000" (4 zeros) if prompted. For those mobile phones featuring Bluetooth 3.0 or higher, no need to enter a password.

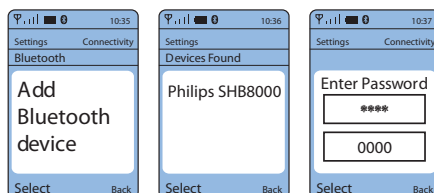

# 4 Use your headset

## Connect the headset to a Bluetooth device

- 1 Turn on your mobile phone/Bluetooth device.
- 2 Press and hold  to turn the headset on.
  - ↳ The blue LED flashes.
  - ↳ The headset is reconnected to the last connected mobile phone/Bluetooth device automatically. If the last one is not available, the headset tries to reconnect to the second last connected device.

### Tip

- If you turn on the mobile phone/Bluetooth device or activate the Bluetooth feature after turning on the headset, you have to reconnect the headset and mobile phone/Bluetooth device manually.

### Note

- If the headset fails to connect to any Bluetooth device within range in 5 minutes, it will switch off automatically to save the battery life.

## Manage your calls and music

### Call/Music button

Task	Operation	Sound or LED indicator
Turn the headset on.	Press and hold for 1 second.	<ul style="list-style-type: none"><li>• 1 short beep</li><li>• 3 white flashes: battery low &lt; 25%</li><li>• 2 white flashes: battery level &lt; 50%</li><li>• 1 blue flash: battery level &gt; 50%</li></ul>
Turn the headset off.	Press and hold for 4 seconds.	<ul style="list-style-type: none"><li>• 1 long beep</li><li>• 1 long white flash</li></ul>
Play or pause music.	Press once.	1 short beep
Pick up/hang up a call.	Press once.	1 short beep
Reject an incoming call.	Press and hold	1 short beep
Redial the last number.	Press twice.	1 short beep
Switch caller during a call.	Press twice	1 long beep

### Volume/Track control button

Adjust volume.	Turn up/down	N/A
Skip forward.	Press once	1 short beep
Skip backward.	Press twice	1 short beep
Mute/unmute the microphone in a call.	Press once	2 short beeps

## Other headset indicator status

Headset status	Indicator
The headset is connected to a Bluetooth device, while the headset in standby mode or while you are listening to music.	Blue LED flashes for every 8 seconds.
The headset is ready for pairing.	LED flashes blue and white alternately.
The headset is on but not connected to a Bluetooth device.	Blue LED flashes quickly.
There is an incoming call.	Blue LED flashes once per second.
Low battery.	White LED flashes.
Battery is fully charged.	White LED is off.

## Wear your headset

Adjust the headband to fit your head.

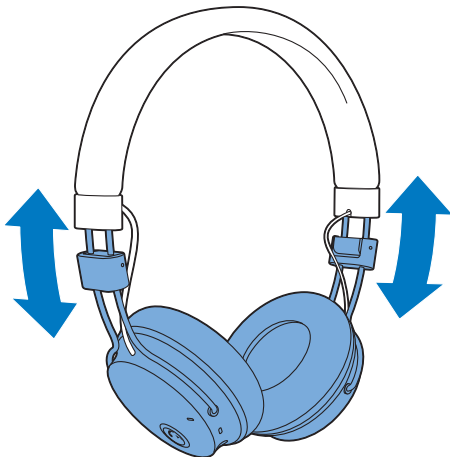

### Tip

- After use, twist the headset for easy storage.

## Use with the audio cable

### Note

- Make sure that you turn off the Bluetooth headset before connecting the audio cable.

With the supplied audio cable, you can use the headset with non-Bluetooth devices or on airplane. No battery power is required for the headset when you use it with the audio cable. Connect the supplied audio cable to

- the headset and;
- an external audio device.

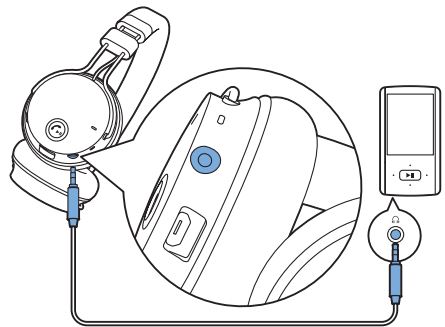



# 5 Technical data

- Minimum 9 hours of music time or talk time
- Minimum 200 hours of standby time
- Normal time for a full charge: 3 hours
- Rechargeable Lithium-Polymer battery (200 mAh)
- 3.5 mm audio jack for corded headset mode
- Bluetooth 3.0, Bluetooth mono support (Headset Profile - HSP, Hands-Free Profile - HFP), Bluetooth stereo supported (Advanced Audio Distribution Profile - A2DP; Audio Video Remote Control Profile - AVRCP)
- Operating range: Up to 15 meters (50 feet)
- Digital echo & noise reduction
- Auto power off



## Note

- Specifications are subject to change without notice.

# 6 Notice

## Declaration of conformity

Hereby Philips Consumer Lifestyle, declares that the SHB8000 is in compliance with the essential requirements and other relevant provisions of Directive 1999/5/EC. You can find the Declaration of Conformity on [www.p4c.philips.com](http://www.p4c.philips.com).

This product has been designed, tested and manufactured according the European R&TTE directive 1999/5/EC.

## Disposal of your old product and batteries



Your product is designed and manufactured with high quality materials and components, which can be recycled and reused.



When this crossed-out wheeled bin symbol is attached to a product it means that the product is covered by the European Directive 2002/96/EC. Please inform yourself about the local separate collection system for electrical and electronic products.

Please act according to your local rules and do not dispose of your old products with your normal household waste.

Correct disposal of your old product helps to prevent potential negative consequences for the environment and human health.



Your product contains batteries covered by the European Directive 2006/66/EC, which cannot be disposed with normal household waste. Please inform yourself about the local rules on separate collection of batteries because correct disposal helps to prevent negative consequences for the environmental and human health.

## Remove the integrated battery



### Note

- Make sure the headset is disconnected from the USB charging cable before removing the battery.

If there is no collection/recycling system for electronic products in your country, you can protect the environment by removing and recycling the battery before disposing the headset.

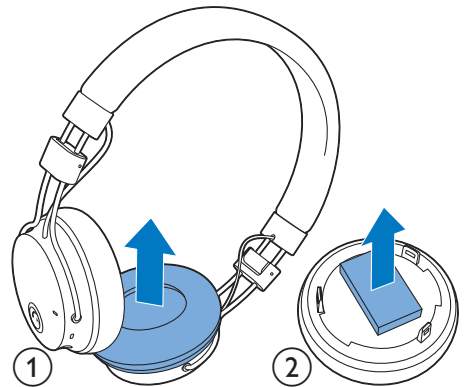

## Environmental information

All unnecessary packaging has been omitted. We have tried to make the packaging easy to separate into three materials: cardboard (box), polystyrene foam (buffer) and polyethylene (bags, protective foam sheet.)

Your system consists of materials which can be recycled and reused if disassembled by

a specialized company. Please observe the local regulations regarding the disposal of packaging materials, exhausted batteries and old equipment.

---

## Notice for the European Union

# CE 0890

Hereby, Philips Consumer Lifestyle, declares that Philips SHB8000 is in compliance with the essential requirements and other relevant provisions of Directive 1999/5/EC.

---

## Trademarks

Trademarks are the property of Koninklijke Philips Electronics N.V. or their respective owners. The **Bluetooth** word mark and logos are owned by the Bluetooth SIG, Inc. and any use of such marks by Koninklijke Philips Electronics N.V. is under license. iPhone, iPad and iPod Touch are trademarks of Apple Inc., registered in the U.S. and other countries.

# 7 Frequently asked questions

## **My Bluetooth headset does not switch on.**

The battery level is low. Charge the headset.

## **I cannot pair my Bluetooth headset with a mobile phone.**

The Bluetooth is disabled. Enable the Bluetooth feature on your mobile phone and turn on the mobile phone before you turn on the headset.

## **Pairing does not work.**

Make sure the headset is in pairing mode.

- Follow the steps described in this user manual (see 'Pair the headset with your mobile phone' on page 4).
- Make sure that the LED light flashes blue and white alternately before you release the call/music button. Do not stop holding the button if you see the blue LED only.

## **The mobile phone cannot find the headset.**

- The headset may be connected to a previously paired device. Turn off the connected device or move it out of range.
- Pairing may have been reset or the headset has been previously paired with another device. Pair the headset with the mobile phone again as described in the user manual (see 'Pair the headset with your mobile phone' on page 4).

## **Voice dialing or redialing does not work on my mobile phone.**

Your mobile phone may not support this feature.

## **The other side cannot hear me on the mobile phone.**

The microphone is muted. Press volume/track control button once to enable the microphone.

**My Bluetooth headset is connected to a Bluetooth stereo enabled mobile phone, but music only plays on the mobile phone speaker.** Refer to the user manual of your mobile phone. Select to listen to music through the headset.

## **The audio quality is poor and crackling noise can be heard.**

The Bluetooth device is out of range. Reduce the distance between your headset and Bluetooth device, or remove obstacles between them.

## **The audio quality is poor when streaming from the mobile phone is very slow, or audio streaming does not work at all.**

Make sure your mobile phone not only supports (mono) HSP/HFP but also supports A2DP (see 'Technical data' on page 7).

## **I hear but cannot control music on my Bluetooth device (e.g. play/pause/skip forward/backward).**

Make sure the Bluetooth audio source supports AVRCP (see 'Technical data' on page 7).

## **My headset does not work when the audio cable is connected.**

Microphone function will be deactivated if a 3.5mm audio cable is connected to the headset. In such case, your headset is only for music enjoyment.

## **How can I restore all original headset settings?**

Press volume/track control button and call music button until the LED flashing white for 5 times sequentially.

**For further support, visit [www.philips.com/support](http://www.philips.com/support).**





Specifications are subject to change without notice  
© 2013 Koninklijke Philips Electronics N.V.  
All rights reserved.

SHB8000\_UM\_00\_EN\_V1.0

**CE 0890**

